



DIGITAL PANEL METER N30P TYPE



USER'S MANUAL



Contents

| | |
|---|----|
| 1. APPLICATION and METER DESIGN | 5 |
| 2. METER SET | 6 |
| 3. BASIC REQUIREMENTS, OPERATIONAL SAFETY | 7 |
| 4. INSTALLATION | 8 |
| 5. SERVICE | 11 |
| 6. RS-485 INTERFACE | 26 |
| 7. ERROR CODES | 46 |
| 8. UPDATING OF SOFTWARE..... | 48 |
| 9. TECHNICAL DATA | 50 |
| 10. ORDER CODES | 53 |
| 11. MAINTENANCE AND GUARANTEE..... | 55 |

1. APPLICATION AND METER DESIGN

The N30P meter is a programmable digital panel meter destined for the measurement of a.c. voltage, a.c. current, active, reactive and apparent power, $\cos \varphi$, $\text{tg } \varphi$, φ , frequency, active, reactive and apparent energy, 15, 30 and 60 minutes' active power, 10 minutes' voltage, 10 seconds' frequency.

Additionally, the meter enables the indication of the current time. The readout field is composed of a display which allows to expose results in red, green and orange colours.

Features of the N30P meter:

- display colour individually in three ranges,
- thresholds of displayed overflows,
- 2 NOC relay alarms operating in 6 modes,
- 2 switched relay alarms operating in 6 modes (option),
- signaling of measuring range overflow,
- automatic setting of the decimal point,
- programming of voltage and current ratios,
- programming of alarm and analog outputs with the reaction on any measured value, independently of the currently displayed value,
- storage of maximal and minimal values of all input quantities,
- reset of all watt-hour meters: active and reactive energy,
- programmed kind of 15, 30 or 60 minutes' active power measurement: mean walking or synchronization with the RTC clock,
- manual synchronization of 15 minutes' power, 10 minutes' voltage,
- monitoring of set parameter values,
- interlocking of parameter introduction by means of a password,
- service of the interface with MODBUS protocol in the RTU mode (option),
- updating of software through interface RS485,
- conversion of the measured value into a standard – programmable current or voltage signal (option),

- highlighting of any measuring unit acc. to the order,
- galvanic separation between terminals: alarm, supply, input, analog output, pulse output, RS-485 interface.

The switching of the alarm output on, is signaled by the highlighting of the output number.

The casing protection grade from the frontal side is IP 65.

Meter overall dimensions: 96 × 48 × 93 mm (with terminals).

The meter casing is made of plastics.



Fig. 1 View of the N30P digital meter

2. METER SET

The set is composed of:

- N30P meter 1 pc
- User's manual 1 pc
- Guarantee card 1 pc
- Clamps to fix in the panel 4 pcs
- Seal 1 pc

When unpacking the meter, please check whether the type and execution code on the data plate correspond to the order.

3. BASIC REQUIREMENTS, OPERATIONAL SAFETY

In the safety service scope, the meter meets the requirements of the EN 61010-1 standard.



Observations concerning the operational safety

- All operations concerning transport, installation, and commissioning as well as maintenance, must be carried out by qualified, skilled personnel, and national regulations for the prevention of accidents must be observed.
- The programming of N30P meter parameters must be carried out after disconnecting measuring circuits
- Before switching the meter on, one must check the correctness of connections to the network.
- Do not connect the meter to the network through an autotransformer.
- Before removing the meter housing, one must switch the supply off and disconnect measuring circuits.
- The removal of the meter housing during the guarantee contract period may cause its cancellation.
- The meter fulfills requirements related to electromagnetic compatibility in the industrial environment
- When connecting the supply, one must remember that a switch or a circuit-breaker should be installed in the building. This switch should be located near the device, easy accessible by the operator, and suitably marked as an element switching the meter off.
- Non-authorized removal of the housing, inappropriate use, incorrect installation or operation, creates the risk of injury to personnel or meter damage. For more detailed information, please study the User's Manual.

4. INSTALLATION

The meter has separable strips with screw terminals which enable the connection of external wires of 2.5 mm^2 cross-section. In execution for current measurement, the plug enables a permanent fixing to the socket by means of screws.

The meter is adapted to be mounted in a panel by means of clamps, acc. to the fig. 2. One must prepare a hole of $92^{+0.6} \times 45^{+0.6} \text{ mm}$ in the panel which the thickness should not exceed 15 mm.

The meter must be introduced from the panel front with disconnected supply voltage. Before the insertion into the panel, one must check the correct placement of the seal. After the insertion into the hole, fix the meter by means of clamps (fig.2).

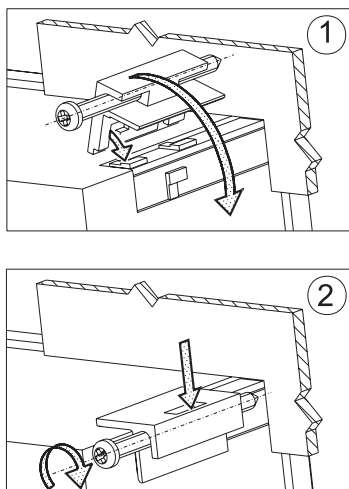

Fig. 2. Meter fixing

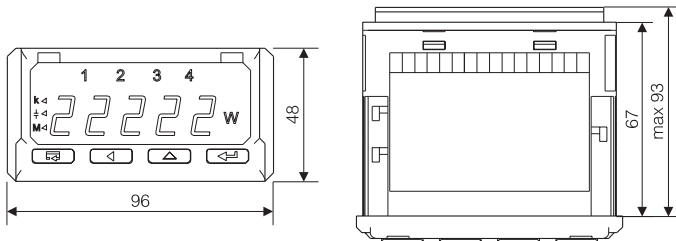

Fig. 3. Overall dimensions

4.1. Connection Diagrams

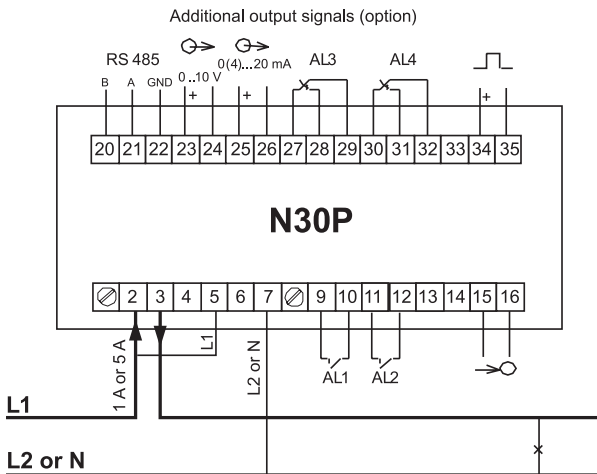

Fig. 4. Electrical connections of the N30P meter for direct measurements

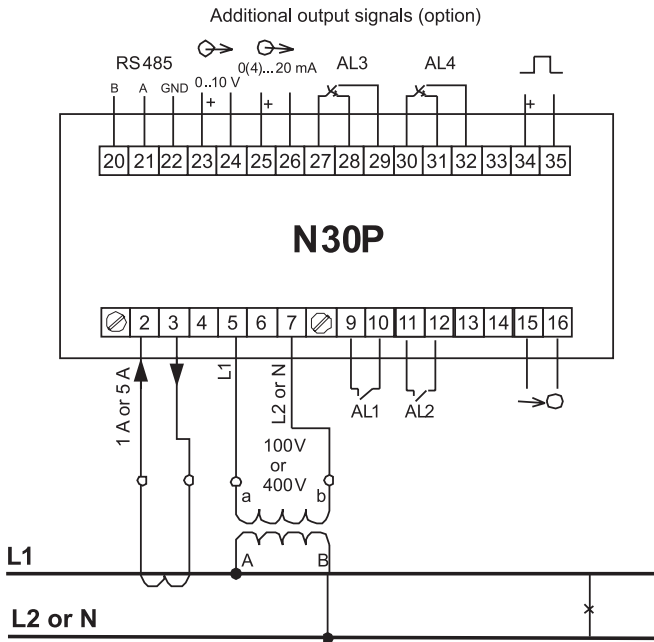

Fig. 5. Electrical connections of the N30P meter for indirect measurements

5. SERVICE

5.1. Display Description

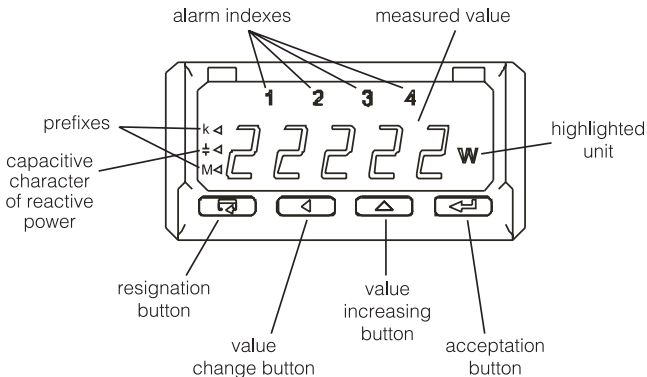

Fig. 6. Description of the meter frontal plate

5.2. Messages after switching the supply on

After switching the switching supply on, the meter displays the meter name N30P and next the program version in the shape „r x.xx” – where x.xx is the number of the current program version or the number of a custom-made execution. Next the meter carries out measurements and displays the value of the input signal. The meter sets automatically the decimal point position when displaying the value, using prefixes k – kilo, M – mega. The overflow of alarm thresholds is signaled by highlighting alarm indexes 1, 2, 3, 4 and switching relays (for alarm 3 and 4 – relays are as option). The meter highlights automatically the unit of the measured value. In case of an error occurrence or any exceeding of the range value, a message described in the chapter 7 will be displayed on the display.

5.3. Functions of buttons



- Acceptation button:

- ⇒ entry in programming mode (hold down ca 3 seconds) (przytrzymanie przez około 3 sekund),
- ⇒ moving through the menu – choice of level,
- ⇒ moving through the menu monitoring the measured values,
- ⇒ entry in the mode changing the parameter value,
- ⇒ acceptance of the changed parameter value.



- Button increasing the value:

- ⇒ display of maximal value,
- ⇒ display of maximal value – menu monitoring the measured parameters,
- ⇒ entry in the level of the parameter group,
- ⇒ moving through the chosen level,
- ⇒ change of the chosen parameter value – increasing the value.



- Button to change the digit:



- ⇒ display of minimal value,
- ⇒ display of minimal value – menu monitoring the measured parameters,
- ⇒ entry in the level of parameter group,
- ⇒ moving through the chosen level,
- ⇒ change of chosen parameter value – shift on the next digit,
- ⇒ next parameter in the monitoring mode of meter parameters.







- resignation button:

- ⇒ entry in the menu monitoring the meter parameters (holding down ca 3 seconds),
- ⇒ exit from the menu monitoring meter parameters and measured values,





- ⇒ resignation of the parameter change,
- ⇒ absolute exit from the programming mode.





The pressure of the button combination   and holding down them ca 3 seconds causes the reset of alarm signaling. This operation acts only when the support function is switched on.



The pressure of the button combination   causes the erasing of all minimal values.

The pressure of the button combination   causes the erasing of all maximal values.

The pressure and holding down the  button ca 3 seconds causes the entry to the programming matrix. The programming matrix is protected by the safety code.

The pressure and holding down the  button 3 seconds causes the entry to the menu monitoring meter parameters. One must move through the monitoring menu by means of  and  buttons. In this menu all programmable meter parameters are only accessible for readout, excepting service parameters. The exit for the monitoring menu is carried out by means of the  button. In the monitoring menu, parameter symbols are displayed alternately with their values. The service algorithm of the meter is presented on the fig. 7.

The pressure and holding down  and  buttons, ca 3 seconds, causes the entry to the menu monitoring measured values. One must move through the monitoring menu by means of ,  and  buttons.

The pressure of the  button causes the display of successive symbol of measured value alternately with the value. The pressure of the  button causes the display of minimal value of the currently displayed value, however the pressure of the  button causes the display of the maximal value of the currently displayed value.

The exit from the monitoring menu is carried out by means of the  button.

In case of capacitive load when the reactive power is displayed a symbol () showing type of load is highlighted. Individual measurements

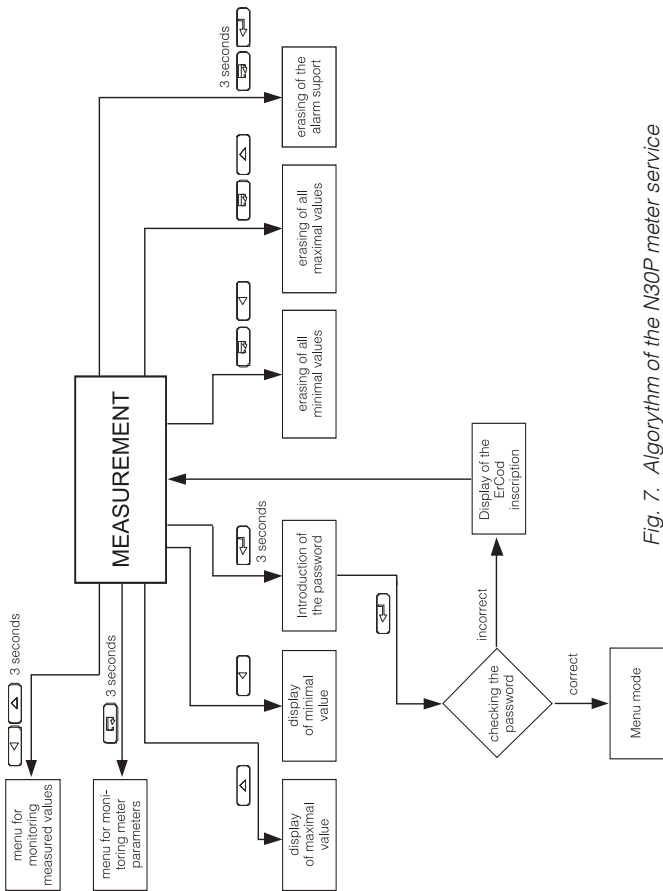











Fig. 7. Algorithm of the N30P meter service

of averaged values are performed, respectively: the averaged power every 15 seconds, the averaged voltage every 5 seconds and the averaged frequency every second. In case of averaged power, at selected 15 min, 30 min, 60 min respectively 60, 120 or 240 measurements are averaged.

When you start the meter or erasing power, the first averaged value of active power will be calculated after 15 seconds after the meter switching on or deletions. Until the samples are gathered, average values are calculated from samples already measured.

5.4. Programming

The pressure of the  button and holding it down through ca 3 seconds causes the entry to the programming matrix. If the entry is protected by a password, then the safety code symbol **SEC** is displayed alternately with the set value **0**. The write of the correct code causes the display of the **ErCod** inscription. The matrix of transitions to the programming mode is presented on the fig. 8. The choice of the level is made by means of the , however the entry and moving through the parameters of the chosen level is carried out by means of the  and  buttons,

Parameter symbols are displayed alternately with their current values. In order to change values, one must use the  button. To resign fo the parameter change, one must press the  button. In order to exit from the chosen level, one must chose the ---- symbol and press the  buton or press the button . To exit from the programming matrix, one must press several times the  button till the appearance of the inscription **End** and after ca 3 seconds, the meter enters automatically in the measurement of the input quantity.



| | | | | | | | | | |
|---------|-----------------------------------|---|---|---|---|---|---|---|--|
| Pos. no | InPUt Input parameters | tYP Type displayed quantity | SYn Type of input synchronization | rAnU Voltage input range | rAnI Current input range | trU Voltage ratio | trI Current ratio | PAvs Synchron. of averaged power | ----- |
| 1 | dISp Display parameters | dP Minimal decimal point | CoLdo Lower colour | CoLbE Middle colour | CoLUP Upper colour | CoLLo Lower threshold of colour change | CoLHI Upper threshold of colour change | ovrLo Lower overflow | ovrHi Upper overflow |
| 2 | ALr1 Alarm 1 | P_A1 Type of input quantity for alarm 1 | PrL_1 Lower threshold | PrH_1 Upper threshold | tYP_1 Alarm type | dLY_1 Alarm delay | LEd_1 Signal support. | ----- | ----- |
| 3 | ALr2 Alarm 2 | P_A2 Type of input quantity for alarm 2 | PrL_2 Lower threshold | PrH_2 Upper threshold | tYP_2 Alarm type | dLY_2 Alarm delay | LEd_2 Signal support. | ----- | ----- |
| 4 | ALr3 Alarm 3 | P_A3 Type of input quantity for alarm 3 | PrL_3 Lower threshold | PrH_3 Upper threshold | tYP_3 Alarm type | dLY_3 Alarm delay | LEd_3 Signal support. | ----- | ----- |
| 5 | ALr4 Alarm 4 | P_A4 Type of input quantity for alarm 4 | PrL_4 Lower threshold | PrH_4 Upper threshold | tYP_4 Alarm type | dLY_4 Alarm delay | LEd_4 Signal support. | ----- | ----- |
| 6 | oUt* Output | P_An Type of input for analog output | An_Lo Lower threshold for analog output | An_HI Upper threshold for analog output | tYP_A Kind of output (volt/curr.) | bAUd Baud rate | Prot Kind of transmission | Addr Device address | ----- |
| 7 | SEr Service parameters | SEt Write of standard parameters | SEC Password introduction | HoUr Time setting | Unit Highlight the unit | C_EnP Reset active energy watt-hour meter | C_EnQ Reset reactive energy watt-hour meter | C_PAV Begin the synchronization of averaged power | C_UAV Begin the synchronization of 10 minutes' voltage |
| 8 | SEr Service parameters | SEt Write of standard parameters | SEC Password introduction | HoUr Time setting | Unit Highlight the unit | C_EnP Reset active energy watt-hour meter | C_EnQ Reset reactive energy watt-hour meter | C_PAV Begin the synchronization of averaged power | C_UAV Begin the synchronization of 10 minutes' voltage |
| | | | | | | | | | tEST Display test |



* Do not occur in the execution without additional output plate.

Fig. 8. Transition matrix in the programming mode

Value Change Way of the Chosen Parameter



Change of Integral Values

In order to increase the value of the chosen parameter, one must press the  button. The single pressure of the button, causes the increase of the value of 1. The holding down of the  button causes a continuous increase of the value on the given digit. The increase of value when displaying the digit 9 causes the setting of 0 on this digit. The change of the digit follows after pressing the  button.

In order to accept the set parameter, one must hold down the  button. Then, the saving of the parameter follows and the display of its symbol alternately with the new value. The pressure of the  button during the change of the parameter value will cause the resignation of the write.

Changing of Values

The change is carried out in three stages (the transition to the next stage follows after pressing the  button):

- 1) setting the value from the range -19999M...99999M, similarly as for integral values;
- 2) setting of the decimal point position (00000., 0000.0, 000.00, 00.000, 0.0000); the  button shifts the decimal point to the left, however the  button shifts the decimal point to the right;
- 3) choice of the prefix: lack, k, M; the  button switches the next prefix; the chosen prefix is displayed in orange.





The pressure of the  button during the change of the parameter value will cause the resignation of the saving.

Table 1



| Parameter symbol | Description | Range of changes |
|------------------|--|--|
| tYP | Choice of the displayed quantity | U – RMS voltage I – RMS current P – active power q – reactive power S – apparent power PF – factor of active power tG – ratio of reactive power to the active power FI – phase shift FrEq - frequency EPPoS – active energy input EPneg – active energy output EqPoS – reactive energy input Eqneg – reactive energy output PAv – mean active power UAv – 10 minutes' mean voltage FAv – 10 seconds' mean frequency HoUr – current time |
| SYn | Type of input synchronization | U – synchronization with voltage (measurement of all values) I – synchronization with current (only measurement of current and frequency) |
| rAnU | Choice of voltage range | 100U – range 100 V 400U – range 400 V |
| rAnI | Choice of current range | 1A – range 1 A 5A – range 5 A |
| trU | Choice of voltage ratio | 1...4000.0 |
| trl | Choice of current ratio | 1...10000 |
| PAv S | Synchronization of averaged active power | 15 – 15 minutes walking window c_15 – measurement every 15 minutes synchronized with the clock c_30 – measurement every 30 minutes synchronized with the clock c_15 – measurement every 60 minutes synchronized with the clock |

| | | |
|--------------|---|---|
| dp | Minimal position of the decimal point when displaying the measured value. | 0.0000 – 0 00.0000 – 1 000.00 – 2 0000.0 – 3 00000 – 4 k 000.00 – 5 k 0000.0 – 6 k 00000 – 7 M 000.00 – 8 M 0000.0 – 9 M 00000 – 10 |
| CoLdo | Display colour when the displayed value is less than CoLLo | rEd – red GrEEen – green orAnG – yellow |
| CoLbE | Display colour when the displayed value is higher than CoLLo and less than CoLHI | |
| CoLUP | Display colour when the displayed value is higher than CoLHI | |
| CoLLo | Lower threshold of display colour change | -19999M ... 99999M |
| CoLHI | Upper threshold of display colour change | -19999M ... 99999M |
| ovrLo | Lower threshold of the display constraint  | -19999M ... 99999M |
| ovrHI | Upper threshold of the display constraint  | -19999M ... 99999M |

| | | |
|--|--|--|
| P_A1 P_A2 P_A3 P_A4 | Kind of input value type, which the alarm has to react on. | U – RMS voltage I – RMS current P – active power q – reactive power S – apparent power PF – active power factor tG – ratio of reactive power to active power FI – phase shift FrEq - frequency EPPoS – active energy input EPnEG – active energy output EqPoS – reactive energy input EqnEG – reactive energy output PAv – 15 minutes' mean active power UAv – 10 minutes' mean voltage FAv – 10 seconds' mean frequency. |
| PrL 1 PrL 2 PrL 3 PrL 4 | Lower alarm threshold. | -19999M ... 99999M |
| PrH 1 PrH 2 PrH 3 PrH 4 | Upper alarm threshold. | -19999M ... 99999M |
| tYP 1 tYP 2 tYP 3 tYP 4 | Alarm type. The fig. 9. presents a graphic display of alarm types. | n-on – normal (transition from 0 to 1), n-off – normal (transition from 1 to 0), on - switched on, off – switched off, H-on – manually switched on; till the time of alarm type change, the alarm output remains switched on for good. H-off – Manually switched off; till the time of alarm type change, the alarm output remains switched off for good. |
| dLY_1 dLY_2 dLY_3 dLY_4 | Delay of alarm switching. | 0...900 seconds |

| | | |
|--|--|--|
| LEd_1 LEd_2 LEd_3 LEd_4 | <p>Supporting of alarm signaling. In the situation when the support function is switched on after the alarm state retreat, the signaling diode is not put out. It signals the alarm state till the moment of its extinction by means of the  button combination. </p> <p>The function concerns only and exclusively the alarm signaling, that is the relay contacts will operate without support in compliance with the chosen alarm type.</p> | on – support switched on off – support switched off |
| P_An | <p>Kind of input value type, which the analog output has to react on.</p> | U – RMS voltage I – RMS current P – active power q – reactive power S – apparent power PF – active power factor tG – ratio of reactive power to active power FI – phase shift FrEq – frequency EPPoS – active energy input EPnEG – active energy output EqPoS – reactive energy input EqnEG – reactive energy output PAv – mean active power UAv – 10 minutes' mean voltage FAv – 10 seconds' mean frequency. |
| An_Lo | <p>Lower threshold of the analog output. One must give the value for which we want to obtain 0 on the analog output.</p> | -19999M ... 99999M |
| An_HI | <p>Upper threshold of the analog output. One must give the value for which we want to obtain the maximal signal on the analog output (20 mA or 10V).</p> | -19999M ... 99999M |
| tYPA | <p>Type of the analog output</p> | 0_10U – voltage 0...10 V 0_20A – current 0...20 mA 4_20A – current 4...20 mA |

| | | |
|--------------|--|--|
| bAUd | Baud rate of the RS-485 interface transmission. | 4800 – 4800 bit/s 9600 – 9600 bit/s 19200 – 19200 bit/s 38400 – 38400 bit/s |
| Prot | Kind of transmission through the RS-485 interface. | r8n2 – RTU 8N2 r8E1 – RTU 8E1 r8o1 – RTU 8O1 r8n1 – RTU 8N1 |
| Addr | Device address | 1...247 |
| SEt | Write of manufacturer settings. Parameter values set by the manufacturer are presented in the table 2. | The setting of the value YES causes the saving of standard parameters in the meter. |
| SEC | Introduction of a new password. | 0...60000 |
| HoUr | Setting of the current time. | 0,00...23,59 The introduction of an erroneous time causes at the acceptance, the setting 23, however the introduction of erroneous minutes will cause the setting of the value 59. |
| UnIt | Selection of measured value for which the unit is highlighted. | U – RMS voltage I – RMS current P – active power q – reactive power S – apparent power PF – active power factor tG – ratio of reactive power to active power FI – phase shift FrEq - frequency EPPoS – active energy input EPnEG – active energy output EqPoS – reactive energy input EqnEG – reactive energy output PAv – mean active power UAv – 10 minutes' mean voltage FAv – 10 seconds' mean frequency. |
| C_EnP | Reset of active watt-hour meters | The choice YES causes the reset of active watt-hour meters |

| | | |
|--------------|---|--|
| C_Enq | Reset of reactive watt-hour meters | The choice YES causes the reset of reactive watt-hour meters. |
| C_PAv | Synchronization of 15 minutes' mean active power | The choice YES causes the beginning of 15 minutes' mean active power measurement. |
| C_UAv | Synchronization of 10 minutes' mean voltage | The choice YES causes the beginning of 10 minutes' mean voltage measurement. |
| tEst | Display test. The test consist on the successive lighting up of digital display segments. Alarm diodes and highlighting diodes should be lighted. | The choice YES causes the switching of the test on. The pressure of the  button ends the test. |
| ----- | Exit from the parameter group of the chosen level. | The pressure of the  button causes the exit from the parameter group of the chosen level. |

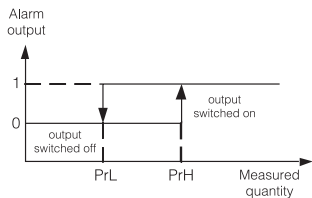

a) n-on

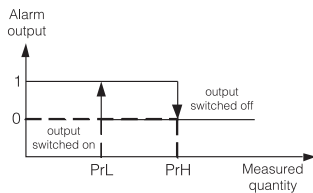

b) n-off

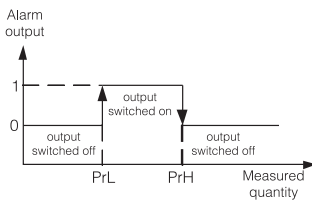

c) on

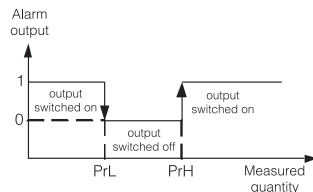

d) off

Fig. 9. Alarm types: a) n-on, b) n-off c) on d) off.

Remaining types of alarms: h-on – always switched on;
h-off – always switched off.

Caution!



- In case of alarms of **n-on**, **n-oFF**, **on**, **oFF** types the write of **PrL>PrH** will cause the alarm switching off.
- In case of a measuring range overflow, the reaction of the n-th relay is compatible with written **PrL_n**, **PrH_n**, **tYP_n** parameters. In spite of the displayed overflow, the meter still carries out the measurement.
- The meter controls currently the value of the introduced parameter at the moment. In case when the introduced value overflows the upper range given in the table 1, the meter will make automatically the change into the maximal value. Similarly, in case when the introduced value overflows the lower change range given in the table 1, the meter will make automatically the change into the minimal value.

5.5. Manufacturer's Parameters

Table 2

| Parameter symbol | Level in the matrix | Standard value |
|------------------|---------------------|----------------|
| tYP | 1 | P |
| SYn | 1 | U |
| rAnU | 1 | 400 U |
| rAnI | 1 | 5 A |
| trU | 1 | 1,0 |
| trl | 1 | 1 |
| PAv S | 1 | 15 |
| dP | 2 | 0.0000 (0) |
| CoLdo | 2 | GrEEEn |
| CoLbE | 2 | orAnG |
| CoLUP | 2 | rEd |
| CoLLo | 2 | 920 |
| CoLHI | 2 | 1150 |
| ovrLo | 2 | 99999M |

| | | |
|-------------------------------|---------|-----------|
| ovrHI | 2 | -19999M |
| P_A 1 | 3 | P |
| PrL_1 | 3 | 920 |
| PrH_1 | 3 | 1150 |
| tYP_1, | 3 | n-on |
| P_A 2 | 4 | I |
| PrL_2 | 4 | 4.000 |
| PrH_2 | 4 | 5.000 |
| tYP_2, | 4 | n-on |
| P_A3 | 5 | U |
| PrL_3 | 5 | 200.00 |
| PrH_3 | 5 | 250.00 |
| tYP_3, | 5 | oFF |
| P_A 4 | 6 | PF |
| PrL_4 | 6 | 0.800 |
| PrH_4 | 6 | 0.999 |
| tYP_4 | 6 | oFF |
| dLY_1, dLY_2, dLY_3, dLY_4 | 3,4,5,6 | 0 |
| LEd_1, LEd_2, LEd_3, LEd_4 | 3,4,5,6 | off |
| P_An | 7 | I |
| tYP_A | 7 | 0...20 mA |
| An_Lo | 7 | 0.000 |
| An_HI | 7 | 5.000 |
| bAUd | 7 | 9600 |
| Prot | 7 | r8n2 |
| Addr | 7 | 1 |
| SEC | 8 | 0 |
| HoUr | 8 | 0.00 |
| Unit | 8 | P |

6. INTERFACE RS-485

N30P programmable digital meters have serial links in RS-485 standards for the communication in computer systems and with other devices fulfilling Master function. An asynchronous communication character protocol MODBUS has been implemented on the serial link. The transmission protocol describes ways of information interchange between devices through the serial link.

6.1. Connection Way of the Serial Interface

The RS-485 standard allows to a direct communication of 32 devices on a single serial link of 1200 m long. For the connection of a higher quantity of devices, it is necessary to apply additional intermediate-separating systems.

The leading of the interface line out is given in the meter user's manual. To obtain a correct transmission, it is necessary to connect lines A and B with their equivalent in other devices. The connection must be made through a shielded wire. The shield must be connected to the protection terminal in a single point. The GND line serves to the additional protection of the interface line at long connections. One must connect it to the pro-

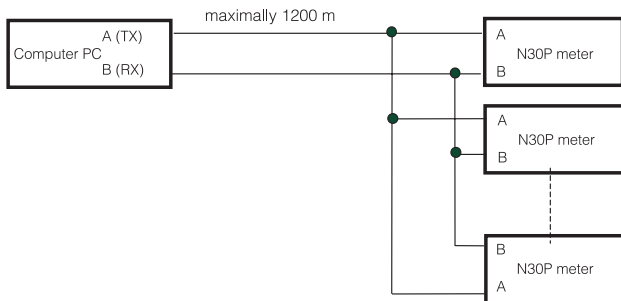

Fig. 10. Connection way of the RS-485 interface

tection terminal (it is not necessary for a correct interface work).

To obtain the connection with a computer of IBM PC class, a RS-485 card or a RS-232/RS-485 converter is indispensable.

The connection way of devices is shown on the fig. 10

The designation of transmission lines for the card in the PC komputer depends on the card producer.

6.2. Description of the MODBUS Protocol Implementation.

The implemented protocol is in accordance with the PI-MBUS-300 Rev G of Modicon Company specification.

Set of the serial link parameters of meters in MODBUS protocol:

- meter address 1...247,
- baud rate 4800, 9600, 19200, 38400 bit/s,
- work modes RTU,
- information unit RTU: 8N2, 8E1, 8O1, 8N1,
- maximal response time 1000 ms
- The maximum number of read records in one query: - 60 registers – 4 bytes,
- 120 registers – 2 bytes.

Parameter configuration of the serial link is described in the further part of the user's manual. It consists on the settlement of the baud rate (**bAUs** parametr), device address (**Addr** parameter), and the type of the configuration unit (**Mode** parameter)

Notice:

Each meter connected to the communication network must have :

- unique address, different from addresses of other devices connected to the network,
- identical baud rate and type of information unit.

Following functions of the MODBUS protocol have been implemented in the N30P meter:

Table 3

| Code | Meaning |
|------|-------------------------------------|
| 03 | Readout of n-registers |
| 04 | Readout of single register |
| 06 | Write of single register |
| 16 | Write of n-registers |
| 17 | Identification of the slave device. |

6.3. Register Map of the N30P Meter

Table 4

| Range of addresses | Value type | Description |
|--------------------|-------------------|--|
| 4000-4100 | integer (16 bits) | Value placed in a 16-bit register. |
| 6000-6113 | float (32 bits) | Value placed in two successive 16-bit registers. Registers include the same data as 32-bit register from the area 7500. Registers are only for readout. The byte order (1-0-3-2) |
| 6200-6227 | float (32 bits) | Value placed in two successive 16-bit registers. Registers include the same data as 32-bit register from the area 7600. Registers can be read out and written. The byte order (1-0-3-2) |
| 7000-7113 | float (32 bits) | Value placed in two successive 16-bit registers. Registers include the same data as 32-bit register from the area 7500. Registers are only for readout. The byte order (3-2-1-0). |
| 7200-7227 | float (32 bits) | Value placed in two successive 16-bit registers. Registers include the same data as 32-bit register from the area 7600. Registers can be read out and written. The byte order (3-2-1-0). |
| 7500-7556 | float (32 bits) | Value placed in a 32-bit register. Registers are only for readout. |
| 7600-7613 | float (32 bits) | Value placed in a 32-bit register. Registers can be read out and written. |

6.4. Registers for Write and Readout

Table 5

| Values placed In 16-bit registers | Symbol | Write (w)/Readout (r) | Range | Description | | | | | | | | | | | | | | | | | | | | | | | | | | | | | | | | | | | | |
|-----------------------------------|---|-----------------------|--------|---|-------|--|---|--|---|---|---|--------------|---|----------------|---|----------------|---|---------------------|---|--------------------------------|---|-------------|---|-----------|---|------------------------|----|-------------------------|----|--------------------------|----|---------------------------|----|-------------------|----|--------------------------|----|-----------------------------|----|--------------|
| 4000 | tYP | w/r | 0...16 | Input type | | | | | | | | | | | | | | | | | | | | | | | | | | | | | | | | | | | | |
| | | | | <table border="1"> <thead> <tr> <th>Value</th> <th></th> </tr> </thead> <tbody> <tr> <td>0</td> <td>RMS voltage</td> </tr> <tr> <td>1</td> <td>RMS current</td> </tr> <tr> <td>2</td> <td>Active power</td> </tr> <tr> <td>3</td> <td>Reactive power</td> </tr> <tr> <td>4</td> <td>Apparent power</td> </tr> <tr> <td>5</td> <td>Active power factor</td> </tr> <tr> <td>6</td> <td>Ratio of reactive/active power</td> </tr> <tr> <td>7</td> <td>Phase shift</td> </tr> <tr> <td>8</td> <td>Frequency</td> </tr> <tr> <td>9</td> <td>Input of active energy</td> </tr> <tr> <td>10</td> <td>Output of active energy</td> </tr> <tr> <td>11</td> <td>Input of reactive energy</td> </tr> <tr> <td>12</td> <td>Output of reactive energy</td> </tr> <tr> <td>13</td> <td>Mean active power</td> </tr> <tr> <td>14</td> <td>10 minutes' mean voltage</td> </tr> <tr> <td>15</td> <td>10 secondes' mean frequency</td> </tr> <tr> <td>16</td> <td>Current time</td> </tr> </tbody> </table> | Value | | 0 | RMS voltage | 1 | RMS current | 2 | Active power | 3 | Reactive power | 4 | Apparent power | 5 | Active power factor | 6 | Ratio of reactive/active power | 7 | Phase shift | 8 | Frequency | 9 | Input of active energy | 10 | Output of active energy | 11 | Input of reactive energy | 12 | Output of reactive energy | 13 | Mean active power | 14 | 10 minutes' mean voltage | 15 | 10 secondes' mean frequency | 16 | Current time |
| Value | | | | | | | | | | | | | | | | | | | | | | | | | | | | | | | | | | | | | | | | |
| 0 | RMS voltage | | | | | | | | | | | | | | | | | | | | | | | | | | | | | | | | | | | | | | | |
| 1 | RMS current | | | | | | | | | | | | | | | | | | | | | | | | | | | | | | | | | | | | | | | |
| 2 | Active power | | | | | | | | | | | | | | | | | | | | | | | | | | | | | | | | | | | | | | | |
| 3 | Reactive power | | | | | | | | | | | | | | | | | | | | | | | | | | | | | | | | | | | | | | | |
| 4 | Apparent power | | | | | | | | | | | | | | | | | | | | | | | | | | | | | | | | | | | | | | | |
| 5 | Active power factor | | | | | | | | | | | | | | | | | | | | | | | | | | | | | | | | | | | | | | | |
| 6 | Ratio of reactive/active power | | | | | | | | | | | | | | | | | | | | | | | | | | | | | | | | | | | | | | | |
| 7 | Phase shift | | | | | | | | | | | | | | | | | | | | | | | | | | | | | | | | | | | | | | | |
| 8 | Frequency | | | | | | | | | | | | | | | | | | | | | | | | | | | | | | | | | | | | | | | |
| 9 | Input of active energy | | | | | | | | | | | | | | | | | | | | | | | | | | | | | | | | | | | | | | | |
| 10 | Output of active energy | | | | | | | | | | | | | | | | | | | | | | | | | | | | | | | | | | | | | | | |
| 11 | Input of reactive energy | | | | | | | | | | | | | | | | | | | | | | | | | | | | | | | | | | | | | | | |
| 12 | Output of reactive energy | | | | | | | | | | | | | | | | | | | | | | | | | | | | | | | | | | | | | | | |
| 13 | Mean active power | | | | | | | | | | | | | | | | | | | | | | | | | | | | | | | | | | | | | | | |
| 14 | 10 minutes' mean voltage | | | | | | | | | | | | | | | | | | | | | | | | | | | | | | | | | | | | | | | |
| 15 | 10 secondes' mean frequency | | | | | | | | | | | | | | | | | | | | | | | | | | | | | | | | | | | | | | | |
| 16 | Current time | | | | | | | | | | | | | | | | | | | | | | | | | | | | | | | | | | | | | | | |
| 4001 | SYn | w/r | 0...1 | Synchronization of input | | | | | | | | | | | | | | | | | | | | | | | | | | | | | | | | | | | | |
| | | | | <table border="1"> <thead> <tr> <th>Value</th> <th></th> </tr> </thead> <tbody> <tr> <td>0</td> <td>Synchronization with the voltage (measurement of all values)</td> </tr> <tr> <td>1</td> <td>Synchronization with the current (only current and frequency)</td> </tr> </tbody> </table> | Value | | 0 | Synchronization with the voltage (measurement of all values) | 1 | Synchronization with the current (only current and frequency) | | | | | | | | | | | | | | | | | | | | | | | | | | | | | | |
| Value | | | | | | | | | | | | | | | | | | | | | | | | | | | | | | | | | | | | | | | | |
| 0 | Synchronization with the voltage (measurement of all values) | | | | | | | | | | | | | | | | | | | | | | | | | | | | | | | | | | | | | | | |
| 1 | Synchronization with the current (only current and frequency) | | | | | | | | | | | | | | | | | | | | | | | | | | | | | | | | | | | | | | | |

| | | | | | |
|------|-----------------|-----|-----------|---|---|
| 4002 | rAn U | w/r | 0...1 | Voltage input range | |
| | | | | Value | |
| | | | | 0 | Range 100 V |
| | | | | 1 | Range 400 V |
| 4003 | rAn I | w/r | 0...1 | Current input range | |
| | | | | Value | |
| | | | | 0 | Range 1 A |
| | | | | 1 | Range 5 A |
| 4004 | tr u | w/r | 1...40000 | Voltage ratio *0.1 | |
| 4005 | tr I | w/r | 1...10000 | Current ratio | |
| 4006 | PAv S | w/r | 0...1 | Synchronization of averaged active power | |
| | | | | Value | |
| | | | | 0 | Walking window |
| | | | | 1 | Measurement every 15 minutes synchronized with the internal clock |
| | | | | 2 | Measurement every 30 minutes synchronized with the internal clock |
| | | | | 3 | Measurement every 60 minutes synchronized with the internal clock |
| 4007 | Reserved | | | | |
| 4008 | Reserved | | | | |
| 4009 | dP | w/r | 0...10 | Minimal decimal point | |
| | | | | Value | |
| | | | | 0 | 0.0000 |
| | | | | 1 | 00.000 |
| | | | | 2 | 000.00 |
| | | | | 3 | 0000.0 |
| | | | | 4 | 00000 |
| | | | | 5 | k 000.00 |
| | | | | 6 | k 0000.0 |
| | | | | 7 | k 00000 |
| | | | | 8 | M 000.00 |
| | | | | 9 | M 0000.0 |
| 10 | M 00000 | | | | |
| 4010 | CoLdo | w/r | 0...2 | Display colour when the displayed value is less than in the register 7600 | |
| | | | | Value | |
| | | | | 0 | red |
| | | | | 1 | green |
| | | | | 2 | orange |

| | | | | | |
|------|--------------|-----|--------|---|--------------------------------|
| 4011 | CoLbE | w/r | 0...2 | Display colour when the displayed value is higher than in the register 7600 and less than in register 7601. | |
| | | | | Value | |
| | | | | 0 | red |
| | | | | 1 | green |
| | | | | 2 | orange |
| 4012 | CoLuP | w/r | 0...2 | Display colour when the displayed value is higher than in the register 7601 | |
| | | | | Value | |
| | | | | 0 | red |
| | | | | 1 | green |
| | | | | 2 | orange |
| 4013 | P_A1 | w/r | 0...15 | Kind of the input quantity type on which the alarm 1 has to react. | |
| | | | | Value | |
| | | | | 0 | RMS voltage |
| | | | | 1 | RMS current |
| | | | | 2 | Active power |
| | | | | 3 | Reactive power |
| | | | | 4 | Apparent power |
| | | | | 5 | Active power factor |
| | | | | 6 | Ratio of reactive/active power |
| | | | | 7 | Phase shift |
| | | | | 8 | Frequency |
| | | | | 9 | Input of active energy |
| | | | | 10 | Output of active energy |
| | | | | 11 | Input of reactive energy |
| | | | | 12 | Output of reactive energy |
| | | | | 13 | 15 minutes' mean active power |
| | | | | 14 | 10 minutes' mean voltage |
| | | | | 15 | 10 secondes' mean frequency |

| | | | | | |
|------|----------------------------|-----|---------|--|--------------------------------|
| 4014 | tYP_1 | w/r | 0...5 | Type of alarm 1 (description – fig. 6) | |
| | | | | Value | |
| | | | | 0 | n-on |
| | | | | 1 | n-oFF |
| | | | | 2 | on |
| | | | | 3 | oFF |
| | | | | 4 | H-on |
| | | | | 5 | H-oFF |
| 4015 | dLY_1 | w/r | 0...120 | Delay of alarm 1 (in seconds) | |
| 4016 | LEd_1 | w/r | 0...1 | Support of alarm 1 signaling | |
| | | | | Value | |
| | | | | 0 | Support switched off |
| | | | | 1 | Support switched on |
| 4017 | P_A2 | w/r | 0...15 | Kind of the input quantity type on which the alarm 2 has to react. | |
| | | | | Value | |
| | | | | 0 | RMS voltage |
| | | | | 1 | RMS current |
| | | | | 2 | Active power |
| | | | | 3 | Reactive power |
| | | | | 4 | Apparent power |
| | | | | 5 | Active power factor |
| | | | | 6 | Ratio of reactive/active power |
| | | | | 7 | Phase shift |
| | | | | 8 | Frequency |
| | | | | 9 | Input of active energy |
| | | | | 10 | Output of active energy |
| | | | | 11 | Input of reactive energy |
| | | | | 12 | Output of reactive energy |
| | | | | 13 | 15 minutes' mean active power |
| | | | | 14 | 10 minutes' mean voltage |
| 15 | 10 seconds' mean frequency | | | | |

| | | | | | |
|------|----------------------------|-----|---------|--|--------------------------------|
| 4018 | tYP_2 | w/r | 0...5 | Type of alarm 2 (description – fig. 6) | |
| | | | | Value | |
| | | | | 0 | n-on |
| | | | | 1 | n-oFF |
| | | | | 2 | on |
| | | | | 3 | oFF |
| | | | | 4 | H-on |
| 5 | H-oFF | | | | |
| 4019 | dLY_2 | w/r | 0...120 | Delay of alarm 2 (in seconds) | |
| 4020 | LEd_2 | w/r | 0...1 | Support of alarm 2 signaling | |
| | | | | Value | |
| | | | | 0 | Support switched off |
| | | | | 1 | Support switched on |
| 4021 | P_A3 | w/r | 0...15 | Kind of the input quantity type on which the alarm 3 has to react. | |
| | | | | Value | |
| | | | | 0 | RMS voltage |
| | | | | 1 | RMS current |
| | | | | 2 | Active power |
| | | | | 3 | Reactive power |
| | | | | 4 | Apparent power |
| | | | | 5 | Active power factor |
| | | | | 6 | Ratio of reactive/active power |
| | | | | 7 | Phase shift |
| | | | | 8 | Frequency |
| | | | | 9 | Input of active energy |
| | | | | 10 | Output of active energy |
| | | | | 11 | Input of reactive energy |
| | | | | 12 | Output of reactive energy |
| | | | | 13 | 15 minutes' mean active power |
| 14 | 10 minutes' mean voltage | | | | |
| 15 | 10 seconds' mean frequency | | | | |

| | | | | | |
|------|----------------------------|-----|---------|--|--------------------------------|
| 4022 | tYP_3 | w/r | 0...5 | Type of alarmu 3 (description – fig. 6) | |
| | | | | Value | |
| | | | | 0 | n-on |
| | | | | 1 | n-oFF |
| | | | | 2 | on |
| | | | | 3 | oFF |
| | | | | 4 | H-on |
| 4023 | dLY_3 | w/r | 0...120 | Delay of alarm 3 (in seconds) | |
| 4024 | LEd_3 | w/r | 0...1 | Support of alarm 3 signaling | |
| | | | | Value | |
| | | | | 0 | Support switched off |
| | | | | 1 | Support switched on |
| 4025 | P_A4 | w/r | 0...15 | Kind of the input quantity type on which the alarm 4 has to react. | |
| | | | | Value | |
| | | | | 0 | RMS voltage |
| | | | | 1 | RMS current |
| | | | | 2 | Active power |
| | | | | 3 | Reactive power |
| | | | | 4 | Apparent power |
| | | | | 5 | Active power factor |
| | | | | 6 | Ratio of reactive/active power |
| | | | | 7 | Phase shift |
| | | | | 8 | Frequency |
| | | | | 9 | Input of active energy |
| | | | | 10 | Output of active energy |
| | | | | 11 | Input of reactive energy |
| | | | | 12 | Output of reactive energy |
| | | | | 13 | Mean active power |
| 14 | 10 minutes' mean voltage | | | | |
| 15 | 10 seconds' mean frequency | | | | |

| | | | | | |
|------|----------------------------|-----|---------|--|--------------------------------|
| 4026 | tYP_4 | w/r | 0...5 | Type of alarm 4 (description – fig. 6) | |
| | | | | Value | |
| | | | | 0 | n-on |
| | | | | 1 | n-oFF |
| | | | | 2 | on |
| | | | | 3 | oFF |
| | | | | 4 | H-on |
| 4027 | dLY_4 | w/r | 0...120 | Delay of alarm 4 (in seconds) | |
| 4028 | LEd_4 | w/r | 0...1 | Support of alarm 4 signaling | |
| | | | | Value | |
| | | | | 0 | Support switched off |
| | | | | 1 | Support switched on |
| 4029 | P_An | w/r | 0...15 | Kind of the input quantity type on which the analog output has to react. | |
| | | | | Value | |
| | | | | 0 | RMS voltage |
| | | | | 1 | RMS current |
| | | | | 2 | Active power |
| | | | | 3 | Reactive power |
| | | | | 4 | Apparent power |
| | | | | 5 | Active power factor |
| | | | | 6 | Ratio of reactive/active power |
| | | | | 7 | Phase shift |
| | | | | 8 | Frequency |
| | | | | 9 | Input of active energy |
| | | | | 10 | Output of active energy |
| | | | | 11 | Input of reactive energy |
| | | | | 12 | Output of reactive energy |
| | | | | 13 | Mean active power |
| 14 | 10 minutes' mean voltage | | | | |
| 15 | 10 seconds' mean frequency | | | | |

| | | | | | |
|------|--------------|-----|-----------|---|--|
| 4030 | tYP_A | w/r | 0...2 | Type of analog output | |
| | | | | Value | |
| | | | | 0 | Voltage 0...10 V |
| | | | | 1 | Current 0...20 mA |
| | | | | 2 | Current 4...20 mA |
| 4031 | bAUd | w/r | 0...3 | Baud rate | |
| | | | | Value | |
| | | | | 0 | 4800 bit/s |
| | | | | 1 | 9600 bit/s |
| | | | | 2 | 19200 bit/s |
| | | | | 3 | 38400 bit/s |
| 4032 | Prot | w/r | 0...3 | Baud rate | |
| | | | | Value | |
| | | | | 0 | RTU 8N2 |
| | | | | 1 | RTU 8E1 |
| | | | | 2 | RTU 8O1 |
| | | | | 3 | RTU 8N1 |
| 4033 | Addr | w/r | 0...247 | Device address | |
| 4034 | sAvE | w/r | 0...1 | Update display parameters | |
| | | | | Value | |
| | | | | 0 | without changes |
| | | | | 1 | update |
| 4035 | SEt | w/r | 0...1 | Write of standard parameters | |
| | | | | Value | |
| | | | | 0 | without changes |
| | | | | 1 | set standard parameters |
| 4036 | SEC | w/r | 0...60000 | Password for parameters | |
| | | | | Value | |
| | | | | 0 | without password |
| | | | | 1...60000 | entry in parameters preceded by a request about the password |
| 4037 | HoUr | w/r | 0...2359 | Current time | |
| | | | | <p>This parameter occurs in the ggmm format, where: gg - means hours, mm – means minutek.</p> <p>The introduction o a wrong hour will cause the setting 23, however the introduction of wrong minutes will generate the setting 59.</p> | |

| | | | | | |
|------|------------------------|-----|--------|--|---|
| 4038 | Unit | w/r | 0...16 | Switch on and off the unit display | |
| | | | | Value | |
| | | | | 0 | RMS voltage |
| | | | | 1 | RMS current |
| | | | | 2 | Active power |
| | | | | 3 | Reactive power |
| | | | | 4 | Apparent power |
| | | | | 5 | Active power factor |
| | | | | 6 | Ratio of reactive/active power |
| | | | | 7 | Phase shift |
| | | | | 8 | Frequency |
| | | | | 9 | active energy |
| | | | | 10 | reactive energy |
| | | | | 11 | apparent energy |
| | | | | 12 | Output of reactive energy |
| | | | | 13 | Mean active power |
| | | | | 14 | 10 minutes' mean voltage |
| | | | | 15 | 10 secondes' mean frequency |
| | | | | 16 | Current time |
| 17 | Switched off for good. | | | | |
| | | | | The unit is displayed when the value In the register 4000 is equal to the value In the register 4038 | |
| 4039 | C_EnP | w/r | 0...1 | Reset of active watt-hour meters | |
| | | | | Value | |
| | | | | 0 | Lack of operation |
| | | | | 1 | Reset of active watt-hour meters |
| 4040 | C_Enq | w/r | 0...1 | Reset of reactive watt-hour meters | |
| | | | | Value | |
| | | | | 0 | Lack of operation |
| | | | | 1 | Reset of reactive watt-hour meters |
| 4041 | C_PAv | w/r | 0...1 | Synchronization of mean power | |
| | | | | Value | |
| | | | | 0 | Lack of operation |
| | | | | 1 | Beginning of the mean power synchronization |

| | | | | | |
|------|--------------|-----|-----------|---|---|
| 4042 | C_UAv | w/r | 0...1 | Synchronization of the 10 minutes' mean voltage | |
| | | | | Value | |
| | | | | 0 | Lack of operation |
| | | | | 1 | Beginning of the 10 minutes' mean voltage synchronization |
| 4043 | LI_0 | w/r | 0...1 | Erasing of minimum and maximum | |
| | | | | Value | |
| | | | | 0 | Lack of operation |
| | | | | 1 | Erasing of minimum and maximum |
| 4044 | StAt | r | 0...65536 | Status register (description below) | |
| 4045 | StAt2 | r | 0...65536 | Status register 2 (description below) | |
| 4046 | | r | 0...65536 | Serial number: two older bytes | |
| 4047 | | r | 0...65536 | Serial number: two younger bytes | |
| 4048 | | r | 0...65536 | Program version (*100) | |
| 4049 | | r | 0...65536 | reserved | |
| 4050 | | r | 0...15258 | Input active energy, two older bytes | |
| 4051 | | r | 0...65536 | Input active energy, two younger bytes | |
| 4052 | | r | 0...15258 | Output active energy, two older bytes | |
| 4053 | | r | 0...65536 | Output active energy, two younger bytes | |
| 4054 | | r | 0...15258 | Inductive reactive energy, two older bytes | |
| 4055 | | r | 0...65536 | Inductive reactive energy, two younger bytes | |
| 4056 | | r | 0...15258 | Capacitive reactive energy, two older bytes | |
| 4057 | | r | 0...65536 | Capacitive reactive energy, two younger bytes | |

Bit-11, bit 10 analog output

| Bit 11 | Bit 10 | Meaning |
|--------|--------|--------------------------------------|
| 0 | 0 | voltage output 0...10 V |
| 0 | 1 | current output 0...20 mA |
| 1 | 0 | current output 4...20 mA |
| 1 | 1 | lack of calibration of analog output |

Bit-9 - „1” - the interval of frequency averaging does not elapse

Bit-8 - „1” - the interval of voltage averaging does not elapse

Bit-7 - „1” - the interval of active power averaging does not elapse

Bit-6 - „1” - too small voltage, current for power factor measurement, tg(fi), fi

Bit-5 - „1” - exceeded the upper range

Bit-4 - „1” - exceeded the lower range

Bit-3 - „1” - alarm 4 switching (relay)

Bit-2 - „1” - alarm 3 switching (relay)

Bit-1 - „1” - alarm 2 switching (relay)

Bit-0 - „1” - alarm 1 switching (relay)

Status 2 register – nature of reactive power (address 4045, R):

Bit-15 - negative active energy difference (register 7518)

Bit-14...3 - reserved

Bit-2 - „1” - capacitive reactive power maximum

Bit-1 - „1” - capacitive reactive power minimum

Bit-0 - „1” - capacitive reactive power

Table 6

| The value placed in two successive 16-bit registers. These registers include the same data as 32-bit registers from the area 7600 | The value is placed in 32-bit registers | Symbol | write (w)/readout (r) | Range | Description |
|---|---|--------------|-----------------------|------------------|--|
| 6200/7200 | 7600 | CoLLo | w/r | -19999M...99999M | Lower threshold of the display colour change |
| 6202/7202 | 7601 | CoLHI | w/r | -19999M...99999M | Upper threshold of the display colour change |
| 6204/7204 | 7602 | ovrLo | w/r | -19999M...99999M | Lower threshold of the display narrowing |
| 6206/7206 | 7603 | ovrHI | w/r | -19999M...99999M | Upper threshold of the display narrowing |
| 6208/7208 | 7604 | PrL_1 | w/r | -19999M...99999M | Lower threshold of alarm 1 (Aoff) |
| 6210/7210 | 7605 | PrH_1 | w/r | -19999M...99999M | Upper threshold of alarm 1 (Aon) |
| 6212/7212 | 7606 | PrL_2 | w/r | -19999M...99999M | Lower threshold of alarm 2 (Aoff) |
| 6214/7214 | 7607 | PrH_2 | w/r | -19999M...99999M | Upper threshold of alarm 2 (Aon) |
| 6216/7216 | 7608 | PrL_3 | w/r | -19999M...99999M | Lower threshold of alarm 3 (Aoff) |
| 6218/7218 | 7609 | PrH_3 | w/r | -19999M...99999M | Upper threshold of alarm 3 (Aon) |
| 6220/7220 | 7610 | PrL_4 | w/r | -19999M...99999M | Lower threshold of alarm 4 (Aoff) |
| 6222/7222 | 7611 | PrH_4 | w/r | -19999M...99999M | Upper threshold of alarm 4 (Aon) |
| 6224/7224 | 7612 | An_Lo | w/r | -19999M...99999M | Lower threshold of analog output |
| 6226/7226 | 7613 | An_HI | w/r | -19999M...99999M | Upper threshold of analog output |

6.5. Registers only for Readout

Table 7

| The value placed in two successive 16-bit registers. These registers include the same data as 32-bit registers from the area 7500 | The value is placed in 32-bit registers | Name | write (w)/readout (r) | Unit | Name of the quantity |
|---|---|-----------------|-----------------------|------|---|
| 6000/7000 | 7500 | Identifier | r | – | Constant identifying the device 179 (0xB3) - N30P |
| 6002/7002 | 7501 | Status | r | – | Status is register describing the current state of the meter (the same value as in register 4044) |
| 6004/7004 | 7502 | Control | r | % | It is a register defining the control of the analog output |
| 6006/7006 | 7503 | Minimum | r | – | Minimal value of the currently displayed value |
| 6008/7008 | 7504 | Maksimum | r | – | Maximal value of the currently displayed value |
| 6010/7010 | 7505 | Displayed Value | r | – | Currently displayed value |
| 6012/7012 | 7506 | Reserved | | | |
| 6014/7014 | 7507 | Reserved | | | |
| 6016/7016 | 7508 | Reserved | | | |
| 6018/7018 | 7509 | U | r | V | RMS voltage |
| 6020/7020 | 7510 | I | r | A | RMS current |
| 6022/7022 | 7511 | P | r | W | Active power |

| | | | | | |
|-----------|------|---|---|-------|--|
| 6024/7024 | 7512 | Q | r | var | Reactive power |
| 6026/7026 | 7513 | S | r | VA | Apparent power |
| 6028/7028 | 7514 | PF | r | | Active power factor |
| 6030/7030 | 7515 | tG | r | | Ratio of reactive/active power |
| 6032/7032 | 7516 | Fl | r | ° | Phase shift |
| 6034/7034 | 7517 | FrEq | r | Hz | Frequency |
| 6036/7036 | 7518 | The absolute value of the difference of the active energy: the absorbed active energy – the given back active energy | | | |
| 6038/7038 | 7519 | Sum of the passive energy: the inductive passive energy + the capacitive passive energy | | | |
| 6040/7040 | 7520 | Reserved | | | |
| 6042/7042 | 7521 | PAv | r | W | 15 minutes' mean power |
| 6044/7044 | 7522 | UAv | r | V | 10 minutes' mean voltage |
| 6046/7046 | 7523 | FAv | r | Hz | 10 seconds' mean frequency |
| 6048/7048 | 7524 | HoUr | r | gg,mm | Current time |
| 6050/7050 | 7525 | U_min | r | V | Minimal value of RMS voltage |
| 6052/7052 | 7526 | U_max | r | V | Maximal value of RMS voltage |
| 6054/7054 | 7527 | I_min | r | A | Minimal value of RMS current |
| 6056/7056 | 7528 | I_max | r | A | Maximal value of RMS current |
| 6058/7058 | 7529 | P_min | r | W | Minimal value of active power |
| 6060/7060 | 7530 | P_max | r | W | Maximal value of active power |
| 6062/7062 | 7531 | Q_min | r | var | Minimal value of reactive power |
| 6064/7064 | 7532 | Q_max | r | var | Maximal value of reactive power |
| 6066/7066 | 7533 | S_min | r | VA | Minimal value of apparent power |
| 6068/7068 | 7534 | S_max | r | VA | Maximal value of apparent power |
| 6070/7070 | 7535 | PF_min | r | | Minimal value of active power factor |
| 6072/7072 | 7536 | PF_max | r | | Maximal value of active power factor |
| 6074/7074 | 7537 | tG_min | r | | Minimal value of reactive/active power ratio |

| | | | | | |
|-----------|------|----------|---|----------|---|
| 6076/7076 | 7538 | tG_max | r | | Maximal value of reactive/active power ratio |
| 6078/7078 | 7539 | FI_min | r | ° | Minimal value of phase shift |
| 6080/7080 | 7540 | FI_max | r | ° | Maximal value of phase shift |
| 6082/7082 | 7541 | FrEq_min | r | Hz | Minimal value of frequency |
| 6084/7084 | 7542 | FrEq_max | r | Hz | Maximal value of frequency |
| 6086/7086 | 7543 | PAv_min | r | W | Minimal value of mean active power |
| 6088/7088 | 7544 | PAv_max | r | W | Maximal value of mean active power |
| 6090/7090 | 7545 | UAv_min | r | V | Minimal value of 10 minutes' mean voltage |
| 6092/7092 | 7546 | UAv_max | r | V | Maximal value of 10 minutes' mean voltage |
| 6094/7094 | 7547 | FAv_min | r | Hz | Minimal value of 10 seconds' mean frequency |
| 6096/7096 | 7548 | FAv_max | r | Hz | Maximal value of 10 seconds' mean frequency |
| 6098/7098 | 7549 | EP_PoS1 | r | 100MWh | Active energy input (the counter of turning the register 7550 is reset every 9999999.9 kWh) |
| 6100/7100 | 7550 | EP_PoS2 | r | kWh | Active energy input (modulo 100000.0) |
| 6102/7102 | 7551 | EP_nEG1 | r | 100MWh | Active energy output (the counter of turning the register 7552 is reset every 9999999.9 kWh) |
| 6104/7104 | 7552 | EP_nEG2 | r | kWh | Active energy output (modulo 100000.0) |
| 6106/7106 | 7553 | Eq_PoS1 | o | 100Mvarh | Reactive energy input (the counter of turning the register 7554 is reset every 9999999.9 kVarh) |
| 6108/7108 | 7554 | Eq_PoS2 | o | kvarh | Reactive energy input (modulo 100000.0) |
| 6110/7110 | 7555 | Eq_nEG1 | o | 100Mvarh | Reactive energy output (turning counter of the register 7556 is reset every 9999999.9 kVarh) |
| 6112/7112 | 7556 | Eq_nEG2 | o | kvarh | Reactive energy output (modulo 100000.0) |

7. ERROR CODES

After switching the meter to the network, messages about errors can appear. Reasons about errors are presented below.

The appearance of below mentioned symbols on digital displays means:



Overflow of upper value of programmed indication range.



Overflow of lower value of programmed indication range.

ErCAL

Loss of meter calibration values. One must contact the service workshop.

EroUt

Loss of calibration values of meter analog outputs. The pressure of the ESC button switches the message off, analog outputs remain switched off. One must contact the service shop.

Er EE

Innapropriate values in meter configuring data. The pressure of the ESC button switched the message off. One must set meter parameters again.

ErEnr

Incorrect energy values in the meter. The pressure of the ESC button switched the message off. Energies are reset.

ErCod

Password incorrectly introduced.

During the meter operation, messages about errors can appear. Reasons of errors are presented below:

- 1) **ErOvr** - when the voltage and/or current is too small or too high during the measurement:
 - P_{fi} , $\text{tg}\varphi_i$, φ below 5% U_n , 0,5 % I_n
 - f below 5% U_n

- 2) **ErPAv** - the full interval of the power P_{Av} averaging time is not going by.

- 3) **ErUAv** - the full interval of the voltage U_{Av} averaging time is not going by.

- 4) **ErFAv** - the full interval of the frequency F_{Av} averaging time is not going by.

8. UPDATING OF SOFTWARE

Function enabling updating of software from the computer of the PC with software LPCon was implementation in meter N30P in the realization with the interface RS485. The connected to the computer convertor RS485 is required on USB to the updating, e.g.: the convertor PD10.

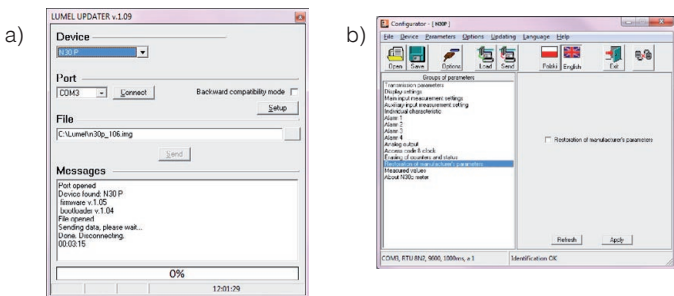



Fig. 11. Program view: a) LPCon, b) updating of software

Warning! Before doing update, currently settings of meter should be saved by program LPCon, because when software is updated default settings of meter are restored.

After starting LPCon's software COM port, baudrate, transmission mode and adress should be set. It can be done in Options. Then, N30P meter should be selected from Device. Push icon Load to read and save current settings. Open window Lumel Updater (LU) – figure 14b from Updating->Updating of devices firmware. Push Connect. Update progress is shown in Messages section. Text Port opened appear after correctly opened port. Putting meter in update's mode can be done in two ways: remote from LU (with settings from LPCon – port, baudrate, transmission mode and adress) or by turning power on while button

 pressed. AL1 led signals that device is ready for update. LU will show message „Device found” with name and current version of firmware. Using button  a valid file should be selected. If the file is correct, message File opened will show. Send button should be pressed. If firmware update is successful device starts normal operation and message Done and update duration will show. Close LU and go to Restoration of manufacturer’s parameters. Select checkbox and press Apply button. Next press Send button to restore previously read parameters. Current firmware version can be checked when meter is power on.

Warning! Power loss during firmware update could result permanent meter damage!

9. TECHNICAL DATA

Measuring Ranges

Table 8

| Measured value | Indication range | Measuring range | Basic error |
|----------------------------------|-------------------------------------|--------------------------------------|-------------------|
| Current 1 A 5 A | 0.000...12 kA 0.000... 60 kA | 0.005...1.200 A~ 0.025...6.000 A~ | ±0.2% |
| Voltage L-N 100 V 400 V | 0.0...0.48 MV 0.0 ...1.92 MV | 5...120 V 20...480 V | ±0.2% |
| Frequency | 45.00...100.00 Hz | <u>45.0...66.0</u> ...100 Hz | ±0.2% |
| Active power | -19999... 99999 MW | -2.88 kW...1.40 W...2.88 kW | ±0.5% |
| Reactive power | -19999 Mvar...0.00 ...99999 Mvar | -2.88 kvar...1.40 var...2.88 kvar | ±0.5% |
| Apparent power | 0.00...99999 MVA | 1.40 VA... 2.88 kVA | ±0.5% |
| Coefficient PF | -1...0...1 | -1...0...1 | ±0.5% |
| Tangens φ_i | -1.2...0...1.2 | -1.2...0...1.2 | ±1% |
| φ | 0...359 | 0...359 | ±1% |
| Active energy | 0...9 999 999.9 kWh | 0...9 999 999.9 kWh | ±0.5% |
| Reactive energy | 0...9 999 999.9 kvarh | 0...9 999 999.9 kvarh | ±0.5% |
| Current time | 0.00...23.59 | 0.00...23.59 | 1 second /24 h |

Ku – voltage transformer ratio: 0.1...4000.0

Ki – current transformer ratio: 1...10000

Relay outputs

- relays, voltageless NOC contacts
load-carrying capacity 250 V/0.5 A
- relays, voltageless switched contacts
load-carrying capacity 250 V/0.5 A
(option)

Analog output (option)

- current programmable 0/4...20 mA
load resistance $\leq 500 \Omega$
- voltage programmable 0...10 V
load resistance $\geq 500 \Omega$
- galvanically isolated
- resolution 0.01% of the range

Serial interfaces (option)

RS485: address 1...247
Mode: 8N2, 8E1, 8O1,8N1
Baud rate: 4.8, 9.6, 19.2, 38.4 kbit/s
Transmission protocol: Modbus RTU
Maximal time to begin a response:
1000 ms

Energy pulse output (option)

output of OC type, passive of
A class acc.to EN 62053-31,
supply voltage 18...27 V,
current 10...27 mA

**Pulse constant
of O/C type output**

5000 imp./kWh, independently of
Ku, Ki settings

Galvanic separation between:

- | | |
|-------------------------------------|-------------|
| - supply - measuring input | 3.2 kV d.c. |
| - supply - analog output | 2 kV d.c. |
| - supply - pulse output | 2 kV d.c. |
| - supply - RS485 interface | 2 kV d.c. |
| - measuring input - analog output | 3.2 kV d.c. |
| - measuring input - pulse output | 3.2 kV d.c. |
| - measuring input - RS485 interface | 3.2 kV d.c. |
| - analog input - pulse output | 2 kV d.c. |
| - analog input - RS485 interface | 2 kV d.c. |
| - alarm output - other circuits | 2 kV d.c. |

Protection grade ensured by the casing:

- | | |
|---------------------|-------|
| - from frontal side | IP 65 |
| - from rear side | IP 10 |

Weight 0.2 kg

Dimensions 96 x 48 x 93 mm

Reference Conditions and Rated**Operating Conditions:**

- | | |
|------------------|-----------------------------------|
| - supply voltage | 85...253 V d.c or a.c 40...400 Hz |
| | 20...40 V d.c or a.c 40...400 Hz |

| | |
|-----------------------------------|---|
| - input signal | 0...0.005...1.2I _n ; 0.05...1.2U _n for current, voltage 0...0.1...1.2I _n ; 0...0.1...1.2U _n ; for coefficients P _{f_i} , t _{φ_i} , φ frequency 45...66...100 Hz; sinusoidal (THD ≤ 8%) |
| - power factor | $\frac{-1...0...1}{2}$ |
| - ambient temperature | -25...23...+55°C |
| - storage temperature | -30...+70°C |
| - relative air humidity | 25...95% (inadmissible condensation) |
| - admissible peak factor of: | |
| - current | 2 |
| - voltage | 2 |
| - external magnetic field | 0...400 A/m |
| - short duration overload (5 s): | |
| - voltage inputs | 2U _n (max. 1000 V) |
| - current inputs | 10 I _n |
| - work position | any |
| - minimal distance between meters | 1.5 cm |
| - power consumption: | - supply circuit < 6 VA - in voltage/current circuit < 0.05 VA. |
| - input power | 6 VA |

Additional Errors in % of the basic error:

| | |
|------------------------------------|------------|
| - from frequency of input signals | < 50% |
| - from ambient temperature changes | < 50%/10°C |

Standards Fulfilled by the Meter:

Electromagnetic Compatibility:

- noise immunity acc.to EN 61000-6-2
- noise emissions acc. to EN 61000-6-4

Safety Requirements: acc. to EN 61010-1 standard

- isolation between circuits: basic,
- installation category III,
- pollution level 2,
- maximal phase-to-earth working voltage:
 - for the supply circuit: 300 V
 - for the measuring input 600 V for analog input signals - cat. II (300 V - cat. III)

- for remaining circuit: 50 V
- altitude above sea level < 2000 m,

Preheating Time 15 minutes

10. ORDER CODES

Table 9

| DIGITAL PANEL METER | N30P - | X | X | XX | XX | X | X |
|---|--------|---|---|----|----|----|---|
| Supply: | | | | | | | |
| 85... 253 V a.c./d.c. | | 1 | | | | | |
| 20... 40 V a.c./d.c. | | 2 | | | | | |
| Additional outputs: | | | | | | | |
| lack | | 0 | | | | | |
| pulse output, RS485, analog outputs | | 1 | | | | | |
| pulse output, RS485, analog outputs, switched-over relay outputs | | 2 | | | | | |
| Unit: | | | | | | | |
| unit code number acc. to the tab. 10 | | | | XX | | | |
| Version: | | | | | | | |
| standard | | | | | | 00 | |
| custom-made* | | | | | | XX | |
| Language: | | | | | | | |
| Polish | | | | | | | P |
| English | | | | | | | E |
| other* | | | | | | | X |
| Acceptance tests: | | | | | | | |
| without extra quality requirements | | | | | | | 0 |
| with an extra quality inspection certificate | | | | | | | 1 |
| acc. to customer's request* | | | | | | | X |

* - after agreeing with the manufacturer.

Order example:

The code: **N30P - 1 0 01 00 E 0** means: programmable N30P panel digital meter, supply: 85...253 V a.c., lack of additional outputs, unit "V" acc. to the table 10, standard version, English language, without extra quality requirements,

| Code | Unit | Code | Unit |
|-----------|--------------|-----------|------------------------|
| 00 | lack of unit | 29 | % |
| 01 | V | 30 | %RH |
| 02 | A | 31 | pH |
| 03 | mV | 32 | kg |
| 04 | kV | 33 | bar |
| 05 | mA | 34 | m |
| 06 | kA | 35 | l |
| 07 | W | 36 | s |
| 08 | kW | 37 | h |
| 09 | MW | 38 | m ³ |
| 10 | var | 39 | obr |
| 11 | kvar | 40 | szt |
| 12 | Mvar | 41 | imp |
| 13 | VA | 42 | rsp |
| 14 | kVA | 43 | m/s |
| 15 | MVA | 44 | l/s |
| 16 | kWh | 45 | obr/min |
| 17 | MWh | 46 | rpm |
| 18 | kvarh | 47 | mm/min |
| 19 | Mvarh | 48 | m/min |
| 20 | kVAh | 49 | l/min |
| 21 | MVAh | 50 | m ³ /min |
| 22 | Hz | 51 | szt/h |
| 23 | kHz | 52 | m/h |
| 24 | Ω | 53 | km/h |
| 25 | kΩ | 54 | m ³ /h |
| 26 | °C | 55 | kg/h |
| 27 | °F | 56 | l/h |
| 28 | K | XX | on order ¹⁾ |

1) - After agreeing with the manufacturer

11. MAINTENANCE AND GUARANTEE

The N30P digital panel meter does not require any periodical maintenance.

In case of some incorrect operations:

1. From the Shipping Date, During the Period Given in the Annexed Guarantee Card

One should take the meter down from the installation and return it to the Manufacturer's

Quality Control Dept.

If the meter has been used in compliance with the instructions, the Manufacturer warrants to repair it free of charge.

2. After the Guarantee Period:

One should turn over the meter to repair it in a certified service workshop.

The disassembling of the casing causes the cancellation of the granted guarantee.

Our policy is one of continuous improvement and we reserve the right to make changes in design and specifications of any products as engineering advances or necessity requires and revise the above specifications without notice.

N30P-09B



LUMEL S.A.

ul. Słubicka 1
65-022 Zielona Góra - Poland

Tel.: (48-68) 45 75 100 (exchange)

Fax: (48-68) 45 75 508

e-mail: lumel@lumel.com.pl

<http://www.lumel.com.pl>

Export Department:

Tel.: (48-68) 45 75 302 or 304

Fax: (48-68) 325 40 91

e-mail: export@lumel.com.pl